



2023

www.unalsan.com

TOZ TOPLAMA SİSTEMLERİ

Industrial Dust Collectors

Daima En İyisi,
Daima En Kalitelisi

Always the Best,
Always the Finest Quality

Ünalsan Makine 1981 yılında üretim hayatına başlamıştır. Ünalsan 1994 yılında başladığı toz toplama sistemi imalatıyla kısa zamanda hizmet ettiği sektörün güvenini kazanmıştır. Kalite, güven ve hizmetin adresi. 36 yıllık tecrübemizle Mobilya sektörüne hizmet sunmaktan gurur duyuyoruz.

Ünalsan ilk olarak taş motoru imal etmiş, daha sonra profil kesme makinesi, mozaik silme makinesi, parke silme makinesi gibi ürünleri bünyesinde üreterek TÜRK sanayisine hizmet vermiştir. Ünalsan 1994 yılında başladığı toz toplama sistemi imalatıyla kısa zamanda hizmet ettiği sektörün güvenini kazanmıştır.

Mobilya sektörünün toz emme ihtiyacını dikkate alan firmamız, gerekli fizibilite çalışmalarının ardından toz emme imalatına başlamıştır. O günden bu güne sadece toz emme ve filtreleme sistemleriyle meşgul olmuş, bu alanda kendini geliştirmiş ve yenilemiştir. Ünalsan, Metal Toz ve Talaş Emme Sistemlerinin imalatına seygar tip 1600m³/h normal ve zemin temizlemeli, 5000m³/h ve 7500m³/h yanları açık ürünlerle başlamıştır. Kısa zaman sonra ihtiyaca göre istenilen kapasitede toz emme sistemleri üretmiştir. Diğer ürünlerinin dışında toz toplama siloları ve hava tahliye siklonları gelmektedir. Ünalsan, mobilya ve ahşap sektörünün yanında metal ve plastik sektörünün de toz toplama ihtiyacını karşılamaktadır.

Ünalsan, kaliteyi ucuza sunma ilkesini kendine ilke edinmiştir. Bu ilke doğrultusunda sürekli makine parkurunu geliştirmiş ve üretimini hızlandırmıştır.

We feel proud for offering our experience to you as a service.

Ünalsan was founded in 1981 in Bursa by Osman Fahri Ünal as a small lathe workshop. Ünalsan has manufactured products such as grinder, profile cutter, mosaic polisher and parquet cleaning machine until 1994. Halit Sezgin joined to Ünalsan in 1994 and took over the leadership of Ünalsan. The company has started search new business opportunities and started to manufacture industrial dust collectors. Ünalsan has been producing only dust collectors since 1994. The company has grown to become one of the largest dust collector manufacturer in

Turkey. Ünalsan constantly strengthened its machine department to provide the quality cheaply. Our company established its vehicle fleet of technical service to give the best and fastest service of the sector. It succeeded to slam with its experienced technical service staff. Our goal is to supply the quality to wood industry by blending it with experience.

Always the best, always the finest quality.



X

E

D

N

I

4-5 Silolar
Dust Silos

6-7 Prizmatik Toz Toplama Siloları
Prismatic Dust Collection Silos

8-9 Otomatik Boşaltımlı Modüler Filtre Sistemi
Automatic Drain Modular Filter System

10-11 Modüler Torbalı Filtre Sistemleri
Modular Bag Filter Systems

12 Fanlar
Fans

13 Mobil Toz Filtre Makinaları
Mobile Dust Filter Machines

14-15 3500 m³/h Mobil Toz Filtre Makinaları
3500 m³/h Mobile Dust Filter Machines

16-17 4000 m³/h Mobil Toz Filtre Makinaları
4000 m³/h Mobile Dust Filter Machines

18-19 5000 m³/h Mobil Toz Filtre Makinaları
5000 m³/h Mobile Dust Filter Machines

20-21 6500 m³/h Mobil Toz Filtre Makinaları
6500 m³/h Mobile Dust Filter Machines

22-23 8500 m³/h Mobil Toz Filtre Makinaları
8500 m³/h Mobile Dust Filter Machines

24-25 10000 m³/h Mobil Toz Filtre Makinaları
10000 m³/h Mobile Dust Filter Machines

26 Özel Kalibre Seyyar Toz Toplama Sistemleri
Calibrated Dust Collection System

27 Patlaçlı Toz Toplama Sistemleri
Jet Pulse Dust Collectors

28 Siklonlar
Cyclones

29 Zımpara Masası
Downdraft Table

30 Sprial Boru Ve Bağlantı Elemanları
Sprial Duct and Fittings



Silolar / Dust Silos

HAVA KİLİTLİ
Rotary Valve

TİTREŞİMLİ
Mechanical Vibration

ELEKTROSTATİK TOZ BOYA
Electrostatic Powder Dye



- Toz toplama siloları; toz toplama ve filtrelemenin yanı sıra depolama yapabilen toz toplama sistemleridir.
- Depolanan talaş ister kamyonu boşaltılır, istenirse de katı yakıt kazanlarında yakıt olarak kullanılabilir.
- Depolanan talaşın sıkışmaması ve köprü oluşturmaması için karıştırıcı kullanılır.
- Depolanan talaş boşaltma ağızına helikon konveyör ile taşınır.
- Boşaltma ağızında hava kilidi bulunmaktadır.
- Hava kilidi boşaltma esnasında tozun çevreye yayılmasını önler.
- Torex ile talaş doluluk seviyesi otomatik kontrol altında tutulmaktadır.
- Modüler olarak imal edilmektedir.
- Elektrostatik toz boya ile boyanmaktadır.

- Dust silos; are the dust collection systems which can store the dust besides dust collection and filtration.
- The dust and chips stored either can be emptied in a truck or solid fuel boiler.
- A mixer is used for the stored dust and chips not to be pressed and not to create a layer
- The dust and chips stored is transferred to discharge outlet with worm screw conveyor .
- There is a rotary valve in discharge outlet.
- Rotary valve prevents the dust and chips to scatter out during discharge
- Dust storage level is kept under control automatically with torex
- The silos are manufactured modular.
- The silos are painted with electrostatic powder dye.

50.000 m³/h SİLO

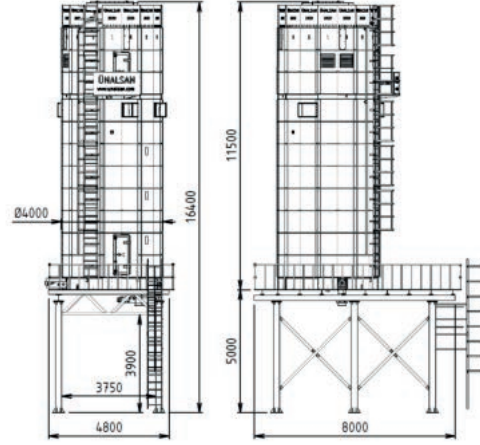

75.000 m³/h SİLO

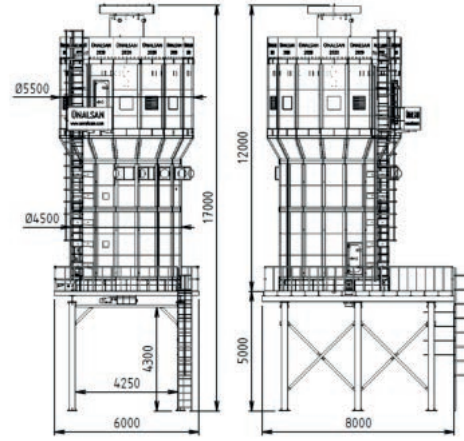

100.000 m³/h SİLO

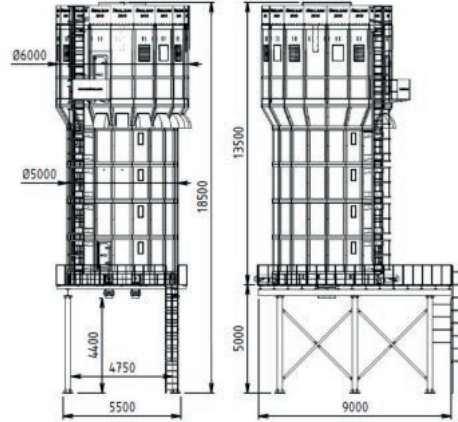

Toz Toplama Siloları / Dust Silos

Model	50.000 m ³ /h SİLO	75.000 m ³ /h SİLO	100.000 m ³ /h SİLO	
KOD	CODE	UNS-540	UNS-545	UNS-560
KAPASİTE(m ³ /h)	CAPACITY (m ³ /h)	50000m ³ /h	75000m ³ /h	100000m ³ /h
ÜNİTE EBATLARI	UNIT DIMENSIONS	4800x8000x16400mm	6000x8000x17000mm	5500x9000x18500mm
SİLO ÇAPI (m)	SILO DIAMETER (m)	4 m	4,5 m	5 m
FİLTRE SAYISI	NUMBER OF FILTER	232 ad.	456 ad.	432 ad.
FİLTRE ÖZELLİKLERİ	FILTER QUALITY	%100 Polyester	%100 Polyester	%100 Polyester
FİLTRE ALAN (m ²)	FILTER AREA (m ²)	291,39m ²	572,73m ²	732,67m ²
TALAŞ KAPASİTESİ (m ³)	SAWDUST CAPACITY (m ³)	75 m ³	75 m ³	130 m ³

Prizmatik Toz Toplama Siloları / Prismatic Dust Collection Silos

HAVA KİLİTLİ
Rotary Valve

TİTREŞİMLİ
Mechanical Vibration

ELEKTROSTATİK TOZ BOYA
Electrostatic Powder Dye

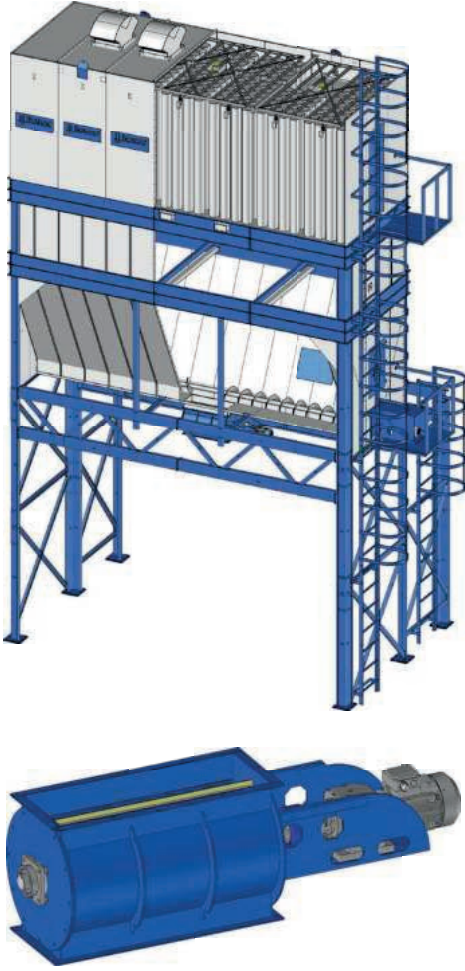

- Prizmatik Toz Toplama Siloları otomatik boşaltmalı sistemlerdir.
- Yatırım maliyeti açısından yuvarlak silolara göre daha ekonomiktir.
- Emiş fanları çalışmaya devam ederken silo boşaltma yapılabilir.
- Talaş dolum miktarını sesli olarak uyarın seviye sensörleri bulunmaktadır.

- Prismatic Dust Collection Silos are automatic discharge systems.
- It is more economical than round silos in terms of investment cost.
- While the suction fans continue to operate, the silo can be emptied.
- There are level sensors that warn the chip filling amount audibly.

Prizmatik Toz Toplama Siloları / Prismatic Dust Collection Silos



35.000 m³/h SİLO

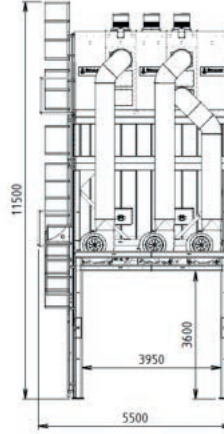
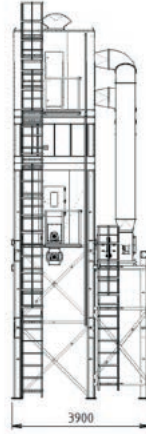

45.000 m³/h SİLO

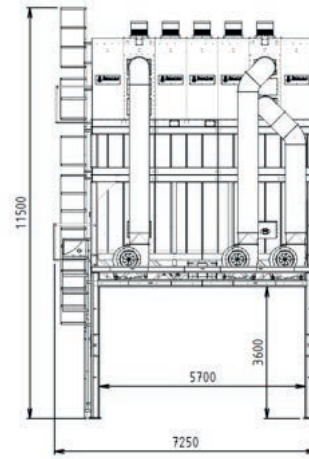
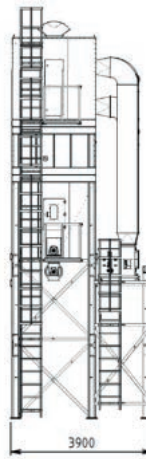

75.000 m³/h SİLO

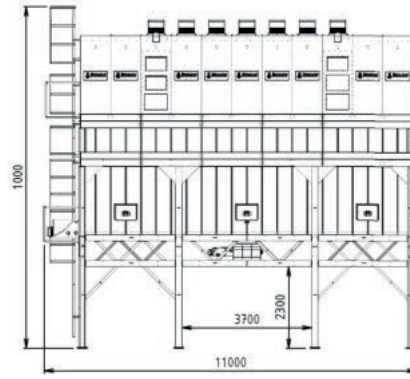

Toz Toplama Siloları / Dust Silos

MODEL		35.000 m ³ /h SİLO	45.000 m ³ /h SİLO	75.000 m ³ /h SİLO
KOD	CODE	UNS-433	UNS-434	UNS-4310
KAPASİTE(m ³ /h)	CAPACITY (m ³ /h)	35000m ³ /h	45000m ³ /h	75000m ³ /h
ÜNİTE EBATLARI	UNIT DIMENSIONS	3900x5500x11500mm	3900x7250x11500mm	2500x11000x10000mm
FİLTRE SAYISI	NUMBER OF FILTER	178	268	438
FİLTRE ÖZELLİKLERİ	FILTER QUALITY	%100 Polyester	%100 Polyester	%100 Polyester
FİLTRE ALAN (m ²)	FILTER AREA (m ²)	185,85m ²	279,82m ²	457,32m ²
TALAŞ KAPASİTESİ (m ³)	SAWDUST CAPACITY (m ³)	12,97 m ³	17,52 m ³	27,32 m ³

Otomatik Boşaltmalı Modüler Filtre Sistemi / Automatic Drain Modular Filter System

HAVA KİLİTLİ
Rotary Valve

TİTREŞİMLİ
Mechanical Vibration

ELEKTROSTATİK TOZ BOYA
Electrostatic Powder Dye



- Ürün Big-Bag Çuvallı otomatik boşaltmalı toz emme sistemidir.
- Alt Boşaltma sistemi hava kilitlidir.
- İstenildiğinde Siloya aktarma yapılabilir.
- Big-Bag çuvalların değişimi ve kullanışlı olması avantaj sağlamaktadır.

- The product is a Big-Bag bag dust extraction system with automatic discharge.
- Bottom Discharge system is air locked.
- It can be transferred to the Silo when requested.
- Big-Bag sacks are advantageous to be changed and useful.

Otomatik Boşaltmalı Modüler Filtre Sistemi / Automatic Drain Modular Filter System



18.000m³/h Filtre Sistemi

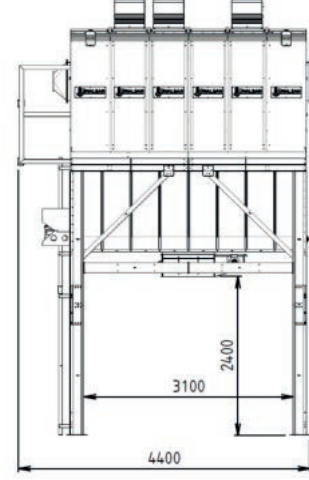
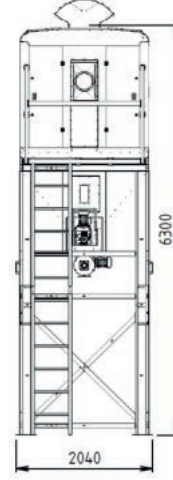

24.000m³/h Filtre Sistemi

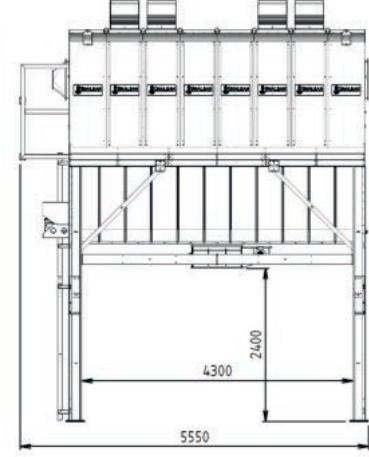
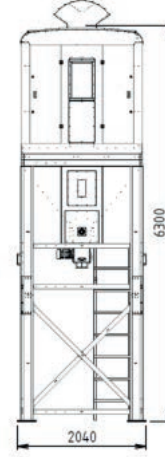

Helezonlu Ortak Modül / Eco Series Worm Screw Dust Collectors

MODEL	MODEL	18.000 m ³ /h HELEZONLU O.MODÜL	24.000 m ³ /h HELEZONLU O.MODÜL
KOD	CODE	UNS445-HLZ	UNS447-HLZ
KAPASİTE(m ³ /h)	CAPACITY (m ³ /h)	18000 m ³ /h	24000 m ³ /h
ÜNİTE EBATLARI ExBxY (mm)	UNIT DIMENSIONS (WxLxH) (mm)	2040x4400x6300 mm	040x5550x6300mm
FİLTRE CİNSİ	TYPE OF FILTER	%100 POLYESTER	%100 POLYESTER
TALAŞ TUTMA KAPASİTESİ	CHP HOLDING CAPACITY	3 MICRON	3 MICRON
VİBRASYON MOTORU ADEDİ	NUMBER OF VIBRATION	2	2
VİBRASYON MOTORU ÖZELLİĞİ	ENGINE VIBRATION FEATURE	0,17 KW 3000 DEV/DAK	0,17 KW 3000 DEV/DAK
HAVA KİLİDİ	ROTARY VALVE	0,75 KW 38D/D 400V KR 203	0,75 KW 38D/D 400V KR 203
HELEZON REDÜKTÖRÜ	SCREMW REDUCER	0,75 KW 13D/D 400V KR 373.00	0,75 KW 13D/D 400V KR 373.00
BASINÇ ODASI	PRESSURE CHAMBER	MEVCUT	MEVCUT
FİLTRE SAYISI	NUMBER OF FILTER	108	144
FİLTRE ÖLÇÜSÜ	FILTER SIZE	Ø160mm L/1680 mm	Ø160mm L/1680 mm
FİLTRE YÜZEY ALAN (m ²)	FILTER SURFACE AREA (m ²)	92,88 m ²	123,84 m ²
FİLTRE AĞIRLIĞI (gr/m ²)	FILTER WEIGHT (gr/m ²)	400 gr/m ²	400 gr/m ²
ÇALIŞMA SICAKLIĞI (°C)	WORKING TEMPERATURE (°C)	-25 C°/ +55 C°	-25 C°/ +55 C°

Modüler Torbalı Filtre Sistemi / Modular Bag Filter Systems

BASINÇ ODALI
Pressure Room

TİTREŞİMLİ
Mechanical Vibration

ELEKTROSTATİK TOZ BOYA
Electrostatic Powder Dye

- Torbalı toz toplama sistemi olarak kullanılmaktadır.
- Ürün modüler olarak üretilmekte olup her modül 3000m³/h filtrasyon kapasitesine sahiptir.
- Torba değişimi kelepçeli yöntem ile basit bir şekilde yapılmaktadır.
- Hava tahliye bacalarından çıkan temiz hava soğuk hava koşullarında tekrar fabrika içerisine verilebilmektedir.
- Maksimum 4 ad. fan bağlanabilmektedir.

- It is used as a bagged dust collection system.
- The product is produced as modular and each module has a filtration capacity of 3000m³/h.
- Bag change is done simply with the clamp method.
- The clean air coming out of the air discharge chimneys can be given back into the factory in cold weather conditions.
- Maximum 4 pcs. fan can be connected.



Ortak Modül / Eco Series Worm Screw Dust Collectors

MODEL	MODEL	9000 m ³ /h O. MODÜL	12000 m ³ /h O. MODÜL	15000 m ³ /h O. MODÜL
KOD	CODE	UNS M552	UNS M553	UNS M554
KAPASİTE(m ³ /h)	CAPACITY (m ³ /h)	9000 m ³ /h	12000 m ³ /h	15000 m ³ /h
ÜNİTE EBATLARI (ExBxY) (mm)	UNIT DIMENSIONS(WxLxH) (mm)	1920X1756X3500	1920X2342X3500	1920X2927X3500
FİLTRE ÖZELLİKLERİ	FILTER QUALITY	Ø160*1680 ÇİFT ESNEK POLYESTER FİLTRE	Ø160*1680 ÇİFT ESNEK POLYESTER FİLTRE	Ø160*1680 ÇİFT ESNEK POLYESTER FİLTRE
FİLTRE SAYISI	NUMBER OF FILTER	54	72	90
FİLTRE ALAN (m ²)	FILTER AREA (m ²)	46,44	61,92	77,4
VİBRASYON MOTORU ÖZELLİĞİ	ENGINE VIBRATION FEATURE	130/3 0,17 KW VİBRO MOTOR	130/3 0,17 KW VİBRO MOTOR	130/3 0,17 KW VİBRO MOTOR
VİBRASYON MOTORU SAYISI	NUMBER OF ENGINE VIBRATION	1	1	1
ÇALIŞMA SICAKLIĞI (°C)	WORKING TEMPERATURE (°C)	-25 C°/ +55 C°	-25 C°/ +55 C°	-25 C°/ +55 C°

Modüler Torbalı Filtre Sistemi / Modular Bag Filter Systems



18000 m ³ /h O. MODÜL	21000 m ³ /h O. MODÜL	24000 m ³ /h O. MODÜL	27000 m ³ /h O. MODÜL	30000 m ³ /h O. MODÜL	33000 m ³ /h O. MODÜL	36000 m ³ /h O. MODÜL
UNS M555	UNS M556	UNS M557	UNS M558	UNS M559	UNS M560	UNS M561
18000 m ³ /h	21000 m ³ /h	24000 m ³ /h	27000 m ³ /h	30000 m ³ /h	33000 m ³ /h	36000 m ³ /h
1920X3513X3500	1920X4100X3500	1920X4685X3500	1920X5270X3500	1920X5855X3500	1920X6440X3500	1920X7025X3500
Ø160*1680 ÇİFT ESNEK POLYESTER FİLTRE	Ø160*1680 ÇİFT ESNEK POLYESTER FİLTRE	Ø160*1680 ÇİFT ESNEK POLYESTER FİLTRE	Ø160*1680 ÇİFT ESNEK POLYESTER FİLTRE	Ø160*1680 ÇİFT ESNEK POLYESTER FİLTRE	Ø160*1680 ÇİFT ESNEK POLYESTER FİLTRE	Ø160*1680 ÇİFT ESNEK POLYESTER FİLTRE
108	126	144	162	180	198	216
92,88	108,36	123,84	139,32	154,8	170,28	185,76
130/3 0,17 KW VİBRO MOTOR	130/3 0,17 KW VİBRO MOTOR	130/3 0,17 KW VİBRO MOTOR	130/3 0,17 KW VİBRO MOTOR	130/3 0,17 KW VİBRO MOTOR	130/3 0,17 KW VİBRO MOTOR	130/3 0,17 KW VİBRO MOTOR
2	2	2	2	2	3	3
-25 C°/ +55 C°	-25 C°/ +55 C°	-25 C°/ +55 C°	-25 C°/ +55 C°	-25 C°/ +55 C°	-25 C°/ +55 C°	-25 C°/ +55 C°

Fanlar / Fans

3000 D/D AKUPLE / DIRECT DRIVE



DEBİSİ AIRFLOW M3/H	KOD CODE	KW	HP	EMİŞ ÇAPI VACUUM DIAMETER	EMİŞ HIZI VACUUM VELOCITY	EBATLAR SIZES (MM)	AĞIRLIK WEIGHT KG
3.500	UNS 310	3	4	200	30 m/sn	630x545x921	70 kg
4.000	UNS 311	3	4	250	30 m/sn	740x631x1028	84 kg
5.000	UNS 312	5,5	7,5	280	32 m/sn	750x731x1028	130 kg
6.500	UNS 313	7,5	10	300	32 m/sn	790x772x1150	138 kg
8.000	UNS 314	11,0	15	355	32 m/sn	900x873x1228	188 kg
10.000	UNS 315	15,0	20	355	32 m/sn	920x870x1245	198 kg
12.500	UNS 316	18,5	25	400	32 m/sn	940x936x1316	268 kg
15.000	UNS 317	22,0	30	450	32 m/sn	1050x1059x1360	320 kg
20.000	UNS 318	30,0	40	500	32 m/sn	1220x1187x1583	420 kg
25.000	UNS 319	37,0	50	560	32 m/sn	1260x1270x1615	520 kg

1500 D/D AKUPLE / DIRECT DRIVE



DEBİSİ AIRFLOW M3/H	KOD CODE	KW	HP	EMİŞ ÇAPI VACUUM DIAMETER	EMİŞ HIZI VACUUM VELOCITY	EBATLAR SIZES (MM)	AĞIRLIK WEIGHT KG
5000	UNS 321	5,5	7,5	280	32 m/sn	880X781X910	179
6.500	UNS 322	7,5	10	300	32 m/sn	078X857X1120	274
8.000	UNS 323	11	15	355	32 m/sn	1210X987X1015	348
10.000	UNS 324	15	20	355	32 m/sn	1140X1091	403
12.500	UNS 325	18,5	25	400	32 m/sn	1340X1115X1235	473

1500 D/D KAYIŞ KASNAKLI / BELT DRIVE



DEBİSİ AIRFLOW M3/H	KOD CODE	KW	HP	EMİŞ ÇAPI VACUUM DIAMETER	EMİŞ HIZI VACUUM VELOCITY	EBATLAR SIZES (MM)	AĞIRLIK WEIGHT KG
5.000	UNS 331	5,5	7,5	280	32 m/sn	80X781X910	191
6.500	UNS 332	7,5	10	300	32 m/sn	61078X857X1120	286
8.000	UNS 333	11	15	355	32 m/sn	1210X987X1015	360
10.000	UNS 334	15	20	355	32 m/sn	1140X1091X1050	415
12.500	UNS 335	18,5	25	400	32 m/sn	1340X1115X1235	485
15.000	UNS 336	22	30	450	32 m/sn	1410X1173X1295	502
20.000	UNS 337	30	40	500	32 m/sn	1520X1265X1397	580
25.000	UNS 338	37	50	560	32 m/sn	1590X1373X1465	632
30.000	UNS 339	45	60	560	32 m/sn	1540X1600X1850	850
35.000	UNS 3310	55	70	600	32 m/sn	1700X1600X1900	1050

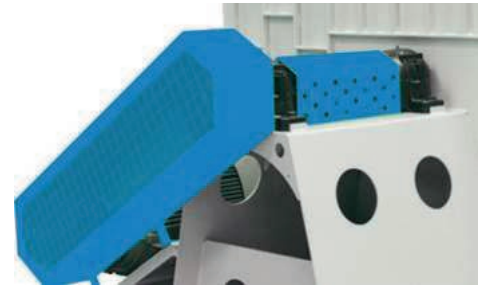

Mobil Toz Filtre Makinaları / Mobile Dust Filter Machines



Uns 283 A

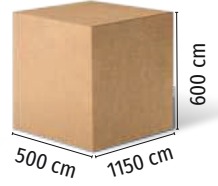
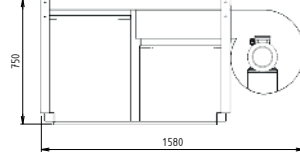
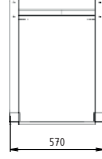

Uns 283 B

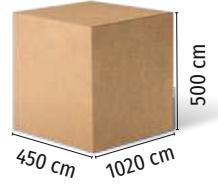
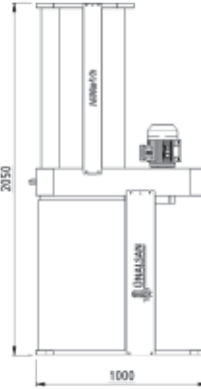
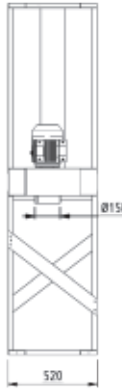

Uns 283 T

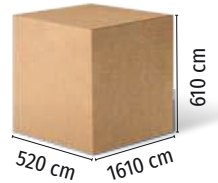
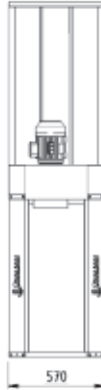

ÜRÜN KODU	CODE	UNS 283 A	UNS 283 B	UNS 283 T
KAPASİTESİ (DEBİ)	CAPACITY	1300m ³ /h	1600 m ³ /h	2500 m ³ /h
MOTOR GÜCÜ	MOTOR POWER	1,1 kw / 1,5 hp 3000 d/d	1.1 kw 1,5 hp 3000dd	1,5kw / 2 hp / 3000 dd
TOZ EMME HIZI	VACUUM VELOCITY	24 m/sn	24 m/sn	24 m/sn
TOZ EMME ÇAPI	VACUUM DIAMETER	Ø120mm	Ø150 mm (Ø80xØ120)	Ø200 mm (Ø80xØ120xØ120)
FİLTRE CİNSİ	FILTER TYPE	İğneli Polyester	İğneli Polyester	İğneli Polyester
FİLTRE GEÇİRGENLİĞİ	DUST HOLDING CAPACITY	3 micron	3 micron	3 micron
FİLTRE ÖLÇÜSÜ	FILTER SIZES	Ø500x600 (mm)	Ø160x935 mm	Ø160x935 mm
FİLTRE ADEDİ	FILTER QUANTITY	1 adet	6 ad.	9 ad.
TALAŞ BİRİKTİRME	DUST STORAGE CAPACITY	Ø500x500 Branda Torba	Ø500x900 mm Branda Torba	Ø500x900 Branda Torba 2 adet
ELEKTRİK	ELECTRICITY	380 v	380 v	380 v
ÖLÇÜLERİ (EN X BOY X H)	SIZES	570x1500x750 mm	520x1000x2050	570x1600x2100 mm
AĞIRLIK	WEIGHT	57 kg	60 kg.	88 kg.

3500m³/h

Mobil Toz Filtre Makinaları / Mobile Dust Filter Machines

AMS35-ET

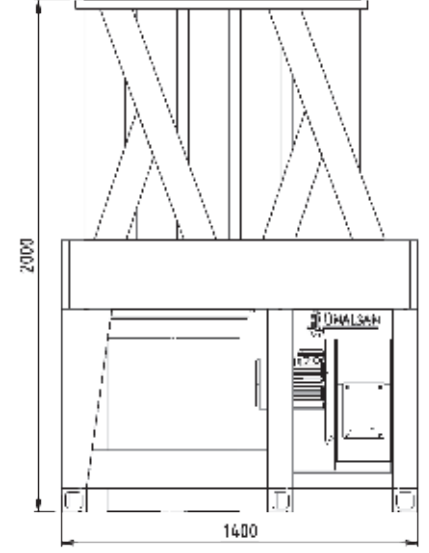
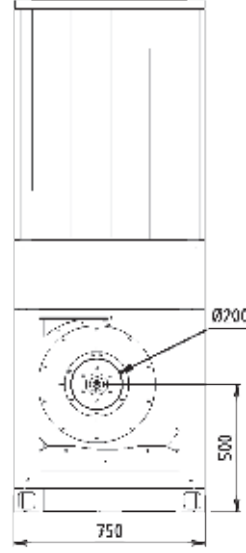

AMS35-EK

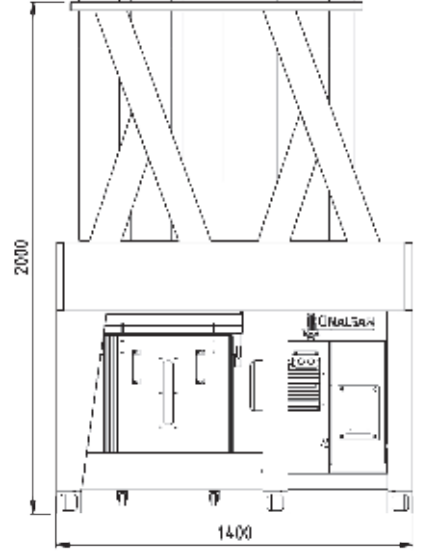
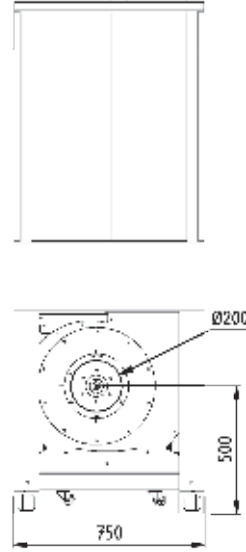

Seyyar Toz Toplama Makinası / Mobile Dust Collector

ÜRÜN KODU	CODE	AMS35-ET	AMS35-EK
KAPASİTESİ (DEBİ)	CAPACITY	3500 m ³ /h	3500 m ³ /h
MOTOR GÜCÜ	MOTOR POWER	3kw / 4 hp / 3000dd	3kw / 4 hp / 3000dd
TOZ EMME HIZI	VACUUM VELOCITY	28 m/sn	28 m/sn
TOZ EMME ÇAPI	VACUUM DIAMETER	3x125 / Ø200 mm	3x125 / Ø200 mm
FİLTRE CİNSİ	FILTER TYPE	Polyester	Polyester
FİLTRE GEÇİRGENLİĞİ	DUST HOLDING CAPACITY	3 micron	3 micron
FİLTRE ÖLÇÜSÜ	FILTER SIZES	Q160 x 935 (mm)	Q160 x 935 (mm)
FİLTRE ADEDİ	FILTER QUANTITY	18 ad.	18 ad.
TALAŞ BİRİKTİRME	DUST STORAGE CAPACITY	Ø520x900mm Pvc Torba	500x500x600mm Metal Kova
ELEKTRİK	ELECTRICITY	380v	380v
ÖLÇÜLERİ(EN X BOY X H)	SIZES	750 x 1400 x 2000mm	750 x 1400 x 2000mm
AĞIRLIK	WEIGHT	170 kg.	205 kg.

3500m³/h

Mobil Toz Filtre Makinaları / Mobile Dust Filter Machines



AMS35-KT

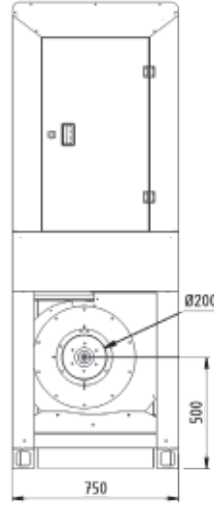

AMS35-KK

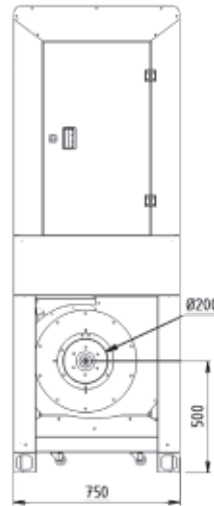

Seyyar Toz Toplama Makinası / Mobile Dust Collector

ÜRÜN KODU	CODE	AMS35-KT	AMS35-KK
KAPASİTESİ (DEBİ)	CAPACITY	3500 m ³ /h	3500 m ³ /h
MOTOR GÜCÜ	MOTOR POWER	3kw / 4 hp / 3000dd	3kw / 4 hp / 3000dd
TOZ EMME HIZI	VACUUM VELOCITY	28 m/sn	28 m/sn
TOZ EMME ÇAPI	VACUUM DIAMETER	Ø200 mm	Ø200 mm
FİLTRE CİNSİ	FILTER TYPE	Polyester	Polyester
FİLTRE GEÇİRGENLİĞİ	DUST HOLDING CAPACITY	3 micron	3 micron
FİLTRE ÖLÇÜSÜ	FILTER SIZES	Q160 x 935 (mm)	Q160 x 935 (mm)
FİLTRE ADEDİ	FILTER QUANTITY	18 ad.	18 ad.
TALAŞ BİRİKTİRME	DUST STORAGE CAPACITY	Ø520x900mm Pvc Torba	500x500x600mm Metal Kova
ELEKTRİK	ELECTRICITY	380v	380v
ÖLÇÜLERİ(EN X BOY X H)	SIZES	750 x 1400 x 2100mm	750 x 1400 x 2100mm
AĞIRLIK	WEIGHT	185 kg.	220 kg.
TİTREŞİM	VIBRATION	Opsiyon	1 ad.

4000m³/h

Mobil Toz Filtre Makinaları / Mobile Dust Filter Machines

AMS40-ET

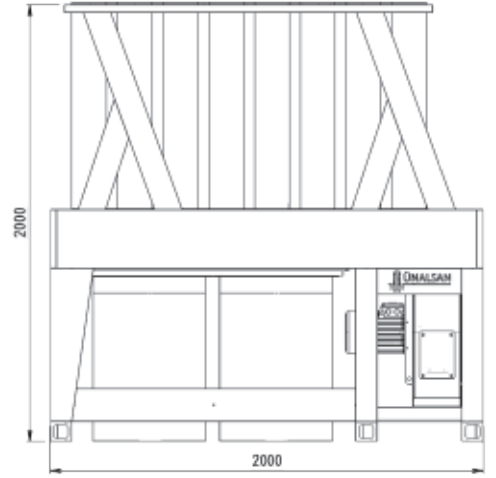
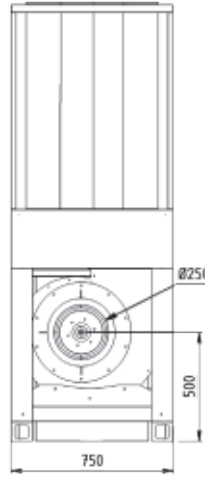

AMS40-EK

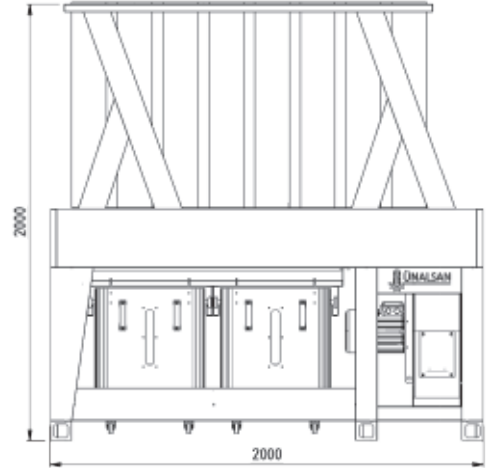
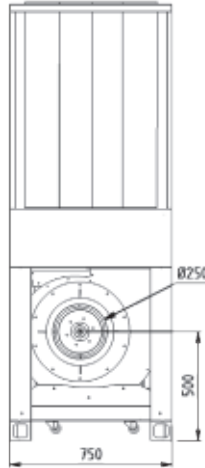

Seyyar Toz Toplama Makinası / Mobile Dust Collector

ÜRÜN KODU	CODE	AMS40-ET	AMS40-EK
KAPASİTESİ (DEBİ)	CAPACITY	4000 m ³ /h	4000 m ³ /h
MOTOR GÜCÜ	MOTOR POWER	3kw / 4 hp / 3000dd	3kw / 4 hp / 3000dd
TOZ EMME HIZI	VACUUM VELOCITY	28 m/sn	28 m/sn
TOZ EMME ÇAPI	VACUUM DIAMETER	Ø250 mm	Ø250 mm
FİLTRE CİNSİ	FILTER TYPE	Polyester	Polyester
FİLTRE GEÇİRGENLİĞİ	DUST HOLDING CAPACITY	3 micron	3 micron
FİLTRE ÖLÇÜSÜ	FILTER SIZES	Q160 x 935 (mm)	Q160 x 935 (mm)
FİLTRE ADEDİ	FILTER QUANTITY	28 ad.	28 ad.
TALAŞ BİRİKTİRME	DUST STORAGE CAPACITY	Ø520x900mm Pvc Torba	500x500x600mm Metal Kova
ELEKTRİK	ELECTRICITY	380v	380v
ÖLÇÜLERİ(EN X BOY X H)	SIZES	750 x 2000 x 2000mm	750 x 2000 x 2000mm
AĞIRLIK	WEIGHT	190 kg.	255 kg.

4000m³/h

Mobil Toz Filtre Makinaları / Mobile Dust Filter Machines



AMS40-KT

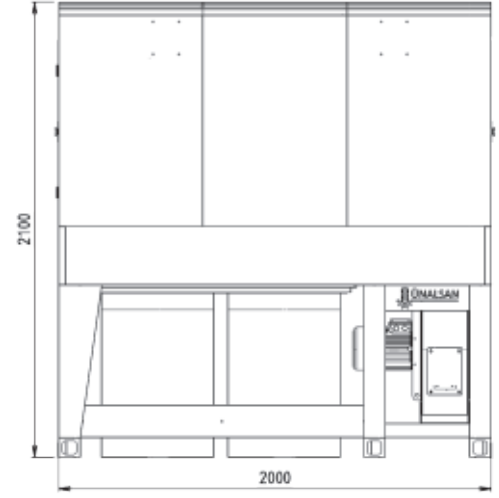
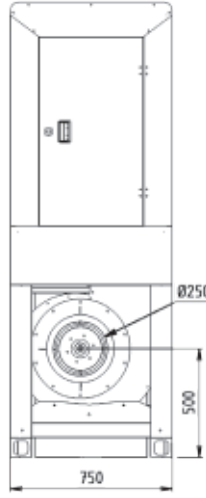

AMS40-KK

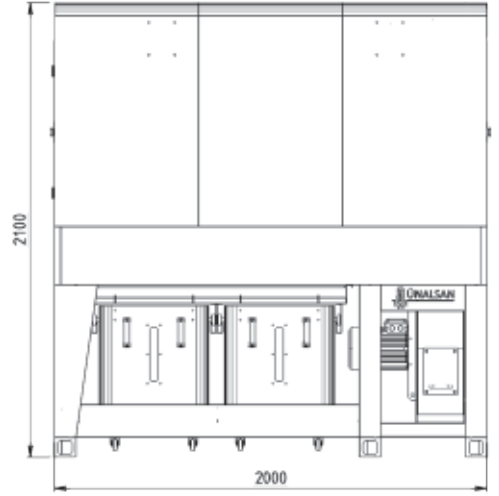
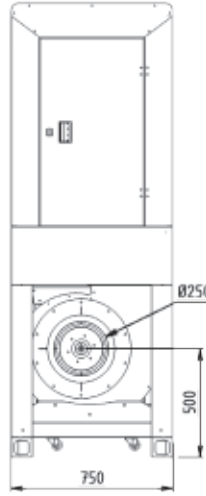

Seyyar Toz Toplama Makinası / Mobile Dust Collector

ÜRÜN KODU	CODE	AMS40-KT	AMS40-KK
KAPASİTESİ (DEBİ)	CAPACITY	4000 m ³ /h	4000 m ³ /h
MOTOR GÜCÜ	MOTOR POWER	3kw / 4 hp / 3000dd	3kw / 4 hp / 3000dd
TOZ EMME HIZI	VACUUM VELOCITY	28 m/sn	28 m/sn
TOZ EMME ÇAPI	VACUUM DIAMETER	Ø250 mm	Ø250 mm
FİLTRE CİNSİ	FILTER TYPE	Polyester	Polyester
FİLTRE GEÇİRGENLİĞİ	DUST HOLDING CAPACITY	3 micron	3 micron
FİLTRE ÖLÇÜSÜ	FILTER SIZES	Q160 x 935 (mm)	Q160 x 935 (mm)
FİLTRE ADEDİ	FILTER QUANTITY	28 ad.	28 ad.
TALAŞ BİRİKTİRME	DUST STORAGE CAPACITY	Ø520x900mm Pvc Torba	500x500x600mm Metal Kova
ELEKTRİK	ELECTRICITY	380v	380v
ÖLÇÜLERİ(EN X BOY X H)	SIZES	750 x 2000 x 2100mm	750 x 2000 x 2100mm
AĞIRLIK	WEIGHT	225 kg.	280 kg.
TİTREŞİM	VIBRATION	Opsiyon	1 ad.

5000m³/h

Mobil Toz Filtre Makinaları / Mobile Dust Filter Machines

AMS50-ET

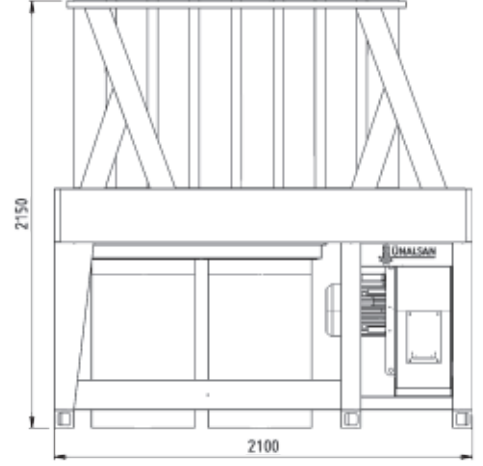
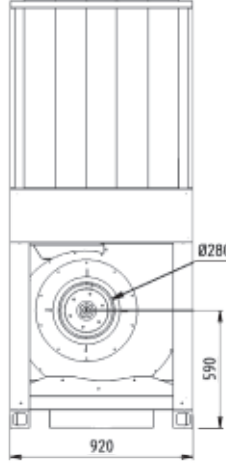

AMS50-EK

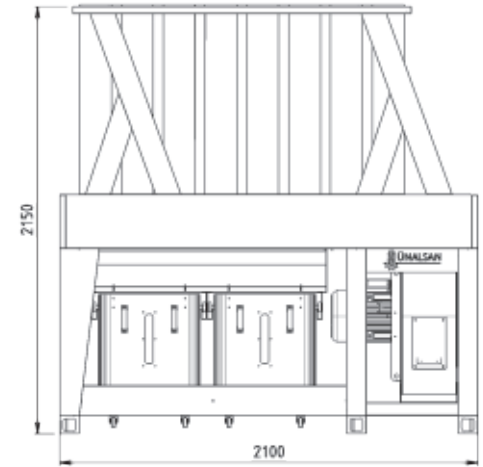
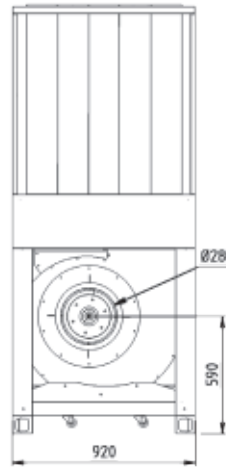

Seyyar Toz Toplama Makinası / Mobile Dust Collector

ÜRÜN KODU	CODE	AMS50-ET	AMS50-EK
KAPASİTESİ (DEBİ)	CAPACITY	5000 m ³ /h	5000 m ³ /h
MOTOR GÜCÜ	MOTOR POWER	5,5kw / 7,5 hp / 3000dd	5,5kw / 7,5 hp / 3000dd
TOZ EMME HIZI	VACUUM VELOCITY	28 m/sn	28 m/sn
TOZ EMME ÇAPI	VACUUM DIAMETER	Ø280 mm	Ø280 mm
FİLTRE CİNSİ	FILTER TYPE	Polyester	Polyester
FİLTRE GEÇİRGENLİĞİ	DUST HOLDING CAPACITY	3 micron	3 micron
FİLTRE ÖLÇÜSÜ	FILTER SIZES	Q160 x 935 (mm)	Q160 x 935 (mm)
FİLTRE ADEDİ	FILTER QUANTITY	35 ad.	35 ad.
TALAŞ BİRİKTİRME	DUST STORAGE CAPACITY	Ø520x900mm Pvc Torba	500x500x600mm Metal Kova
ELEKTRİK	ELECTRICITY	380v	380v
ÖLÇÜLERİ(EN X BOY X H)	SIZES	920 x 2100 x 2150mm	920 x 2100 x 2150mm
AĞIRLIK	WEIGHT	270 kg.	340 kg.

5000m³/h

Mobil Toz Filtre Makinaları / Mobile Dust Filter Machines



AMS50-KT

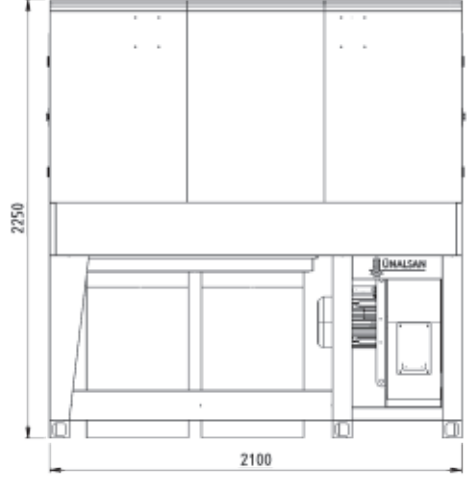
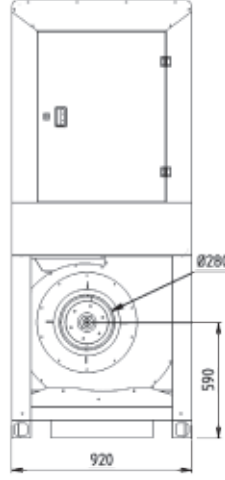

AMS50-KK

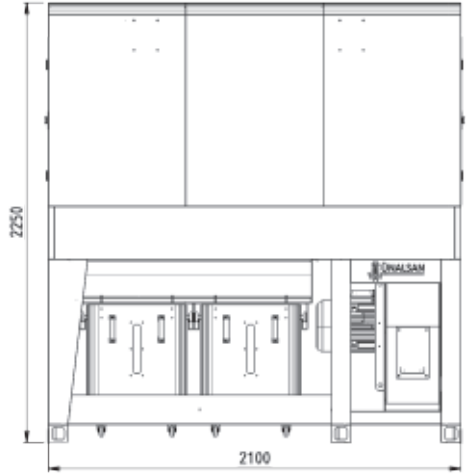
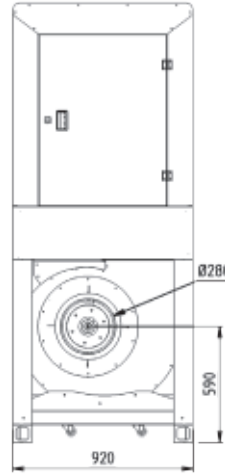

Seyyar Toz Toplama Makinası / Mobile Dust Collector

ÜRÜN KODU	CODE	AMS50-KT	AMS50-KK
KAPASİTESİ (DEBİ)	CAPACITY	5000 m3/h	5000 m3/h
MOTOR GÜCÜ	MOTOR POWER	5,5kw / 7,5 hp / 3000dd	5,5kw / 7,5 hp / 3000dd
TOZ EMME HIZI	VACUUM VELOCITY	28 m/sn	28 m/sn
TOZ EMME ÇAPI	VACUUM DIAMETER	Ø280 mm	Ø280 mm
FİLTRE CİNSİ	FILTER TYPE	Polyester	Polyester
FİLTRE GEÇİRGENLİĞİ	DUST HOLDING CAPACITY	3 micron	3 micron
FİLTRE ÖLÇÜSÜ	FILTER SIZES	Q160 x 935 (mm)	Q160 x 935 (mm)
FİLTRE ADEDİ	FILTER QUANTITY	35 ad.	35 ad.
TALAŞ BİRİKTİRME	DUST STORAGE CAPACITY	Ø520x900mm Pvc Torba	500x500x600mm Metal Kova
ELEKTRİK	ELECTRICITY	380v	380v
ÖLÇÜLERİ(EN X BOY X H)	SIZES	920 x 2100 x 2250mm	920 x 2100 x 2250mm
AĞIRLIK	WEIGHT	355 kg.	410 kg.
TİTREŞİM	VIBRATION	Opsiyon	1 ad.

6500m³/h

Mobil Toz Filtre Makinaları / Mobile Dust Filter Machines

AMS65-ET

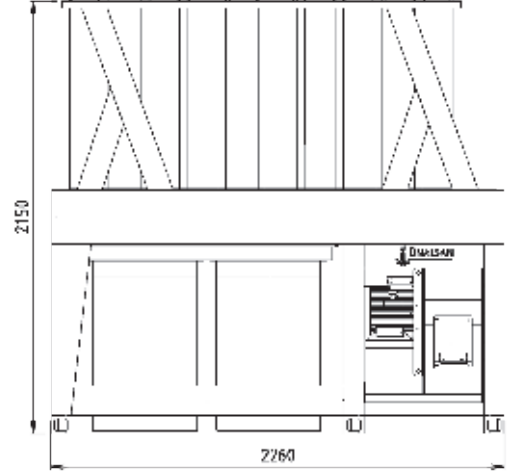
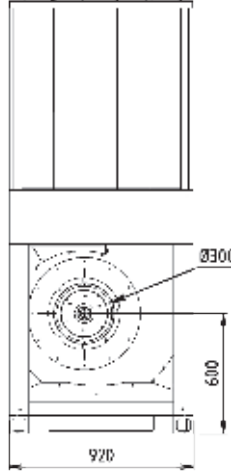

AMS65-EK

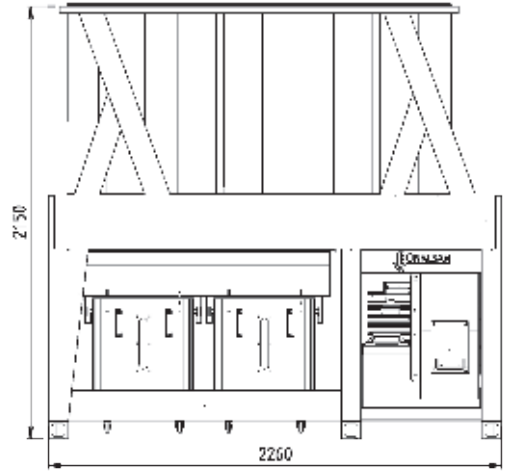
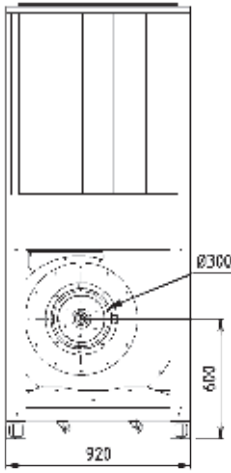

Seyyar Toz Toplama Makinası / Mobile Dust Collector

ÜRÜN KODU	CODE	AMS65-ET	AMS65-EK
KAPASİTESİ (DEBİ)	CAPACITY	6500 m3/h	6500 m3/h
MOTOR GÜCÜ	MOTOR POWER	7,5kw / 10 hp / 3000dd	7,5kw / 10 hp / 3000dd
TOZ EMME HIZI	VACUUM VELOCITY	32 m/sn	32 m/sn
TOZ EMME ÇAPI	VACUUM DIAMETER	Ø300 mm	Ø300 mm
FİLTRE CİNSİ	FILTER TYPE	Polyester	Polyester
FİLTRE GEÇİRGENLİĞİ	DUST HOLDING CAPACITY	3 micron	3 micron
FİLTRE ÖLÇÜSÜ	FILTER SIZES	Q160 x 935 (mm)	Q160 x 935 (mm)
FİLTRE ADEDİ	FILTER QUANTITY	45 ad.	45 ad.
TALAŞ BİRİKTİRME	DUST STORAGE CAPACITY	Ø520x900mm Pvc Torba	500x500x600mm Metal Kova
ELEKTRİK	ELECTRICITY	380v	380v
ÖLÇÜLERİ(EN X BOY X H)	SIZES	920 x 2260 x 2150mm	920 x 2260 x 2150mm
AĞIRLIK	WEIGHT	300 kg.	370 kg.

6500m³/h

Mobil Toz Filtre Makinaları / Mobile Dust Filter Machines



Am s 6 5 - K T

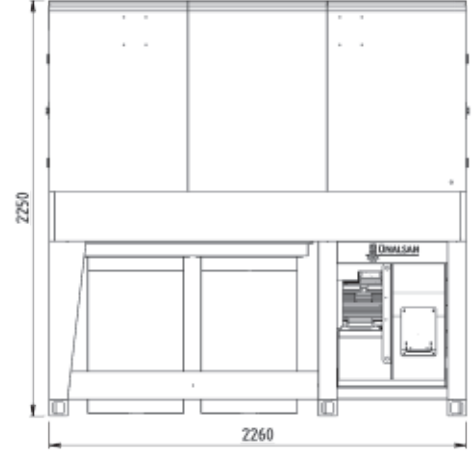
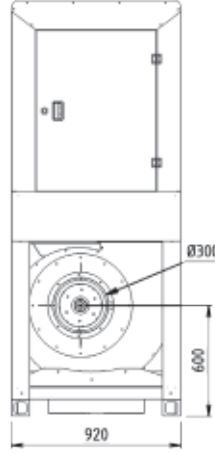

Am s 6 5 - K K

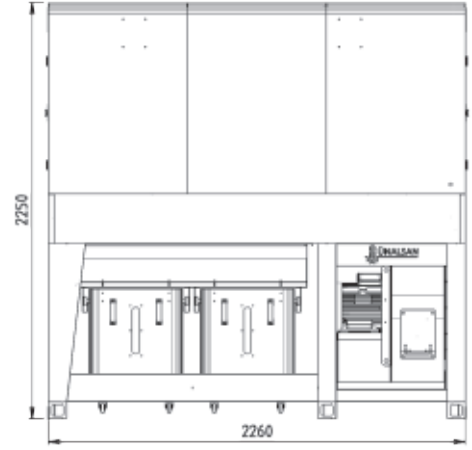
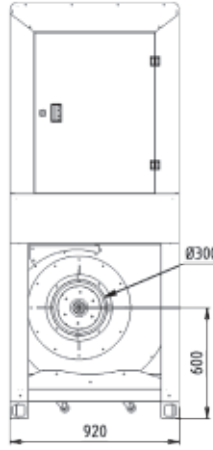

Seyyar Toz Toplama Makinası / Mobile Dust Collector

ÜRÜN KODU	CODE	AMS65-KT	AMS65-KK
KAPASİTESİ (DEBİ)	CAPACITY	6500 m ³ /h	6500 m ³ /h
MOTOR GÜCÜ	MOTOR POWER	7,5kw / 10 hp / 3000dd	7,5kw / 10 hp / 3000dd
TOZ EMME HIZI	VACUUM VELOCITY	32 m/sn	32 m/sn
TOZ EMME ÇAPI	VACUUM DIAMETER	Ø300 mm	Ø300 mm
FİLTRE CİNSİ	FILTER TYPE	Polyester	Polyester
FİLTRE GEÇİRGENLİĞİ	DUST HOLDING CAPACITY	3 micron	3 micron
FİLTRE ÖLÇÜSÜ	FILTER SIZES	Q160 x 935 (mm)	Q160 x 935 (mm)
FİLTRE ADEDİ	FILTER QUANTITY	45 ad.	45 ad.
TALAŞ BİRİKTİRME	DUST STORAGE CAPACITY	Ø520x900mm Pvc Torba	500x500x600mm Metal Kova
ELEKTRİK	ELECTRICITY	380v	380v
ÖLÇÜLERİ(EN X BOY X H)	SIZES	920 x 2260 x 2250mm	920 x 2260 x 2250mm
AĞIRLIK	WEIGHT	375 kg.	450 kg.
TİTREŞİM	VIBRATION	1 ad.	1 ad.

8500m³/h

Mobil Toz Filtre Makinaları / Mobile Dust Filter Machines

AMS85-ET

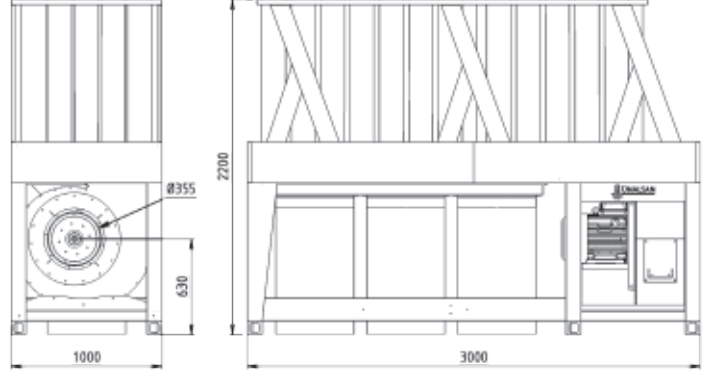

AMS85-EK

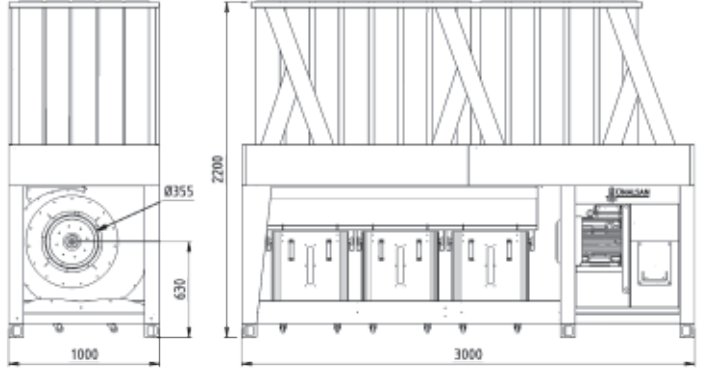

Seyyar Toz Toplama Makinası / Mobile Dust Collector

ÜRÜN KODU	CODE	AMS85-ET	AMS85-EK
KAPASİTESİ (DEBİ)	CAPACITY	8500 m ³ /h	8500 m ³ /h
MOTOR GÜCÜ	MOTOR POWER	11kw / 15 hp / 3000dd	11kw / 15 hp / 3000dd
TOZ EMME HIZI	VACUUM VELOCITY	32 m/sn	32 m/sn
TOZ EMME ÇAPI	VACUUM DIAMETER	Ø355 mm	Ø355 mm
FİLTRE CİNSİ	FILTER TYPE	Polyester	Polyester
FİLTRE GEÇİRGENLİĞİ	DUST HOLDING CAPACITY	3 micron	3 micron
FİLTRE ÖLÇÜSÜ	FILTER SIZES	Q160 x 935 (mm)	Q160 x 935 (mm)
FİLTRE ADEDİ	FILTER QUANTITY	58 ad.	58 ad.
TALAŞ BİRİKTİRME	DUST STORAGE CAPACITY	Ø520x900mm Pvc Torba	500x500x600mm Metal Kova
ELEKTRİK	ELECTRICITY	380v	380v
ÖLÇÜLERİ(EN X BOY X H)	SIZES	1000 x 3000 x 2200mm	1000 x 3000 x 2200mm
AĞIRLIK	WEIGHT	360 kg.	450 kg.

8500m³/h

Mobil Toz Filtre Makinaları / Mobile Dust Filter Machines



AMS85-KT

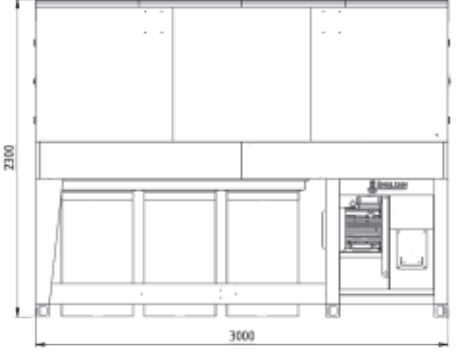
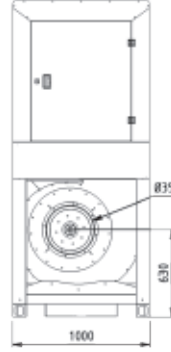

AMS85-KK

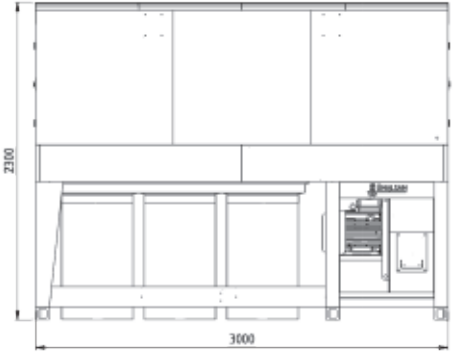
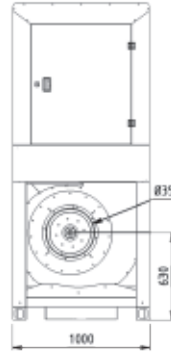

Seyyar Toz Toplama Makinası / Mobile Dust Collector

ÜRÜN KODU	CODE	AMS85-KT	AMS85-KK
KAPASİTESİ (DEBİ)	CAPACITY	8500 m ³ /h	8500 m ³ /h
MOTOR GÜCÜ	MOTOR POWER	11kw / 15 hp / 3000dd	11kw / 15 hp / 3000dd
TOZ EMME HIZI	VACUUM VELOCITY	32 m/sn	32 m/sn
TOZ EMME ÇAPI	VACUUM DIAMETER	Ø355 mm	Ø355 mm
FİLTRE CİNSİ	FILTER TYPE	Polyester	Polyester
FİLTRE GEÇİRGENLİĞİ	DUST HOLDING CAPACITY	3 micron	3 micron
FİLTRE ÖLÇÜSÜ	FILTER SIZES	Q160 x 935 (mm)	Q160 x 935 (mm)
FİLTRE ADEDİ	FILTER QUANTITY	58 ad.	58 ad.
TALAŞ BİRİKTİRME	DUST STORAGE CAPACITY	Ø520x900mm Pvc Torba	500x500x600mm Metal Kova
ELEKTRİK	ELECTRICITY	380v	380v
ÖLÇÜLERİ(EN X BOY X H)	SIZES	1000 x 3000 x 2300mm	1000 x 3000 x 2300mm
AĞIRLIK	WEIGHT	520 kg.	630 kg.
TİTREŞİM	VIBRATION	1 ad.	1 ad.

10.000m³/h

Mobil Toz Filtre Makinaları / Mobile Dust Filter Machines

AMS100-ET

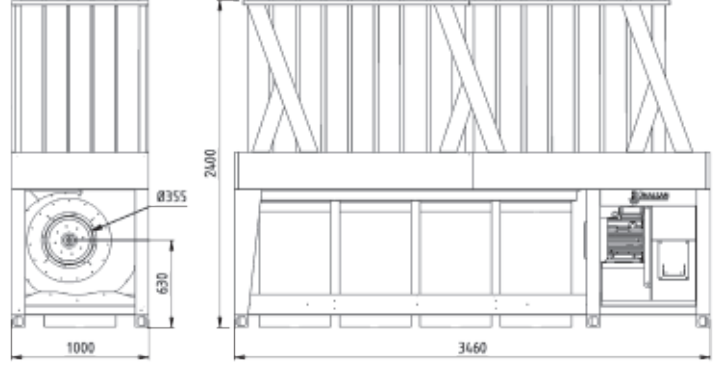

AMS100-EK

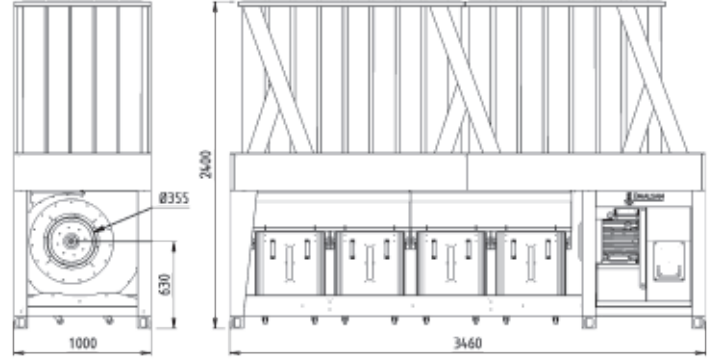
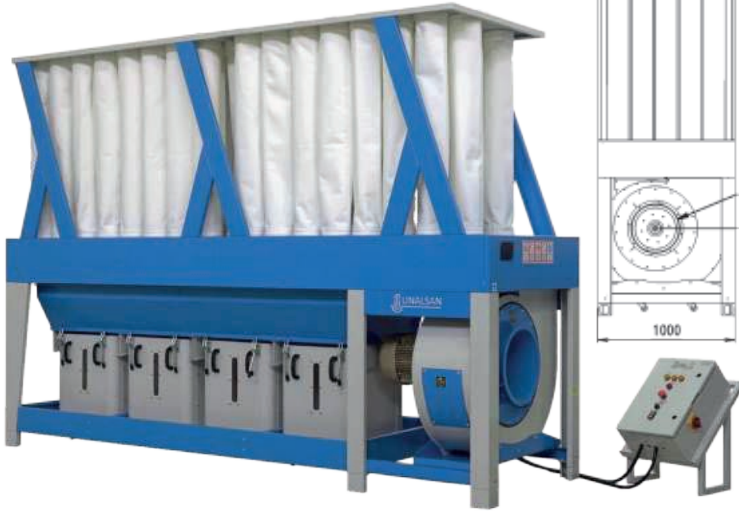

Seyyar Toz Toplama Makinası / Mobile Dust Collector

ÜRÜN KODU	CODE	AMS100-ET	AMS100-EK
KAPASİTESİ (DEBİ)	CAPACITY	10.000 m3/h	10.000 m3/h
MOTOR GÜCÜ	MOTOR POWER	11kw / 15 hp / 3000dd	11kw / 15 hp / 3000dd
TOZ EMME HIZI	VACUUM VELOCITY	32 m/sn	32 m/sn
TOZ EMME ÇAPI	VACUUM DIAMETER	Ø355 mm	Ø355 mm
FİLTRE CİNSİ	FILTER TYPE	Antistatik / Polyester	Antistatik / Polyester
FİLTRE GEÇİRGENLİĞİ	DUST HOLDING CAPACITY	2 micron	2 micron
FİLTRE ÖLÇÜSÜ	FILTER SIZES	Q160 x 1100 (mm)	Q160 x 1100 (mm)
FİLTRE ADEDİ	FILTER QUANTITY	73 ad.	73 ad.
TALAŞ BİRİKTİRME	DUST STORAGE CAPACITY	Ø520x900mm Pvc Torba	500x500x600mm Metal Kova
ELEKTRİK	ELECTRICITY	380v	380v
ÖLÇÜLERİ(EN X BOY X H)	SIZES	1000 x 3460 x 2400mm	1000 x 3460 x 2400mm
AĞIRLIK	WEIGHT	410 kg.	550 kg.

10.000m³/h

Mobil Toz Filtre Makinaları / Mobile Dust Filter Machines



Am s100 - KT

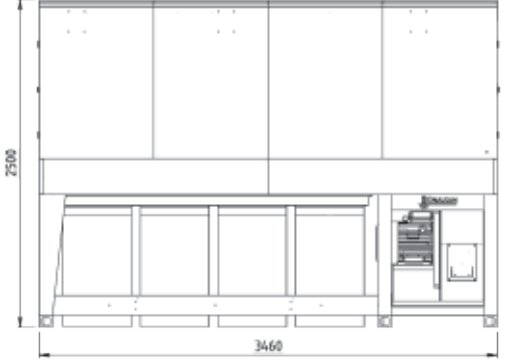
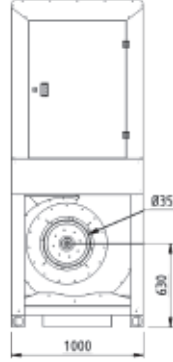

Am s100 - KK

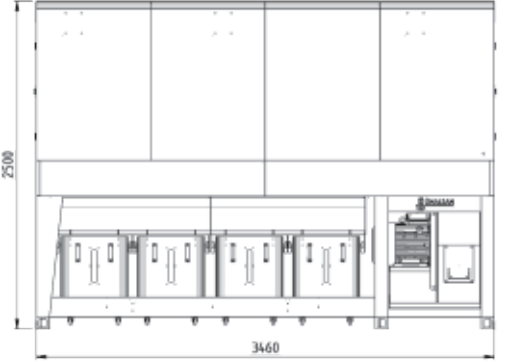
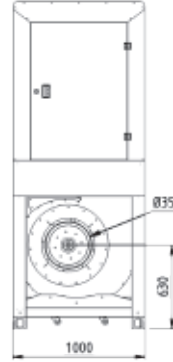

Seyyar Toz Toplama Makinası / Mobile Dust Collector

ÜRÜN KODU	CODE	AMS100-KT	AMS100-KK
KAPASİTESİ (DEBİ)	CAPACITY	10.000 m3/h	10.000 m3/h
MOTOR GÜCÜ	MOTOR POWER	11kw / 15 hp / 3000dd	11kw / 15 hp / 3000dd
TOZ EMME HIZI	VACUUM VELOCITY	32 m/sn	32 m/sn
TOZ EMME ÇAPI	VACUUM DIAMETER	Ø355 mm	Ø355 mm
FİLTRE CİNSİ	FILTER TYPE	Antistatik / Polyester	Antistatik / Polyester
FİLTRE GEÇİRGENLİĞİ	DUST HOLDING CAPACITY	2 micron	2 micron
FİLTRE ÖLÇÜSÜ	FILTER SIZES	Q160 x 1100 (mm)	Q160 x 1100 (mm)
FİLTRE ADEDİ	FILTER QUANTITY	73 ad.	73 ad.
TALAŞ BİRİKTİRME	DUST STORAGE CAPACITY	Ø520x900mm Pvc Torba	500x500x600mm Metal Kova
ELEKTRİK	ELECTRICITY	380v	380v
ÖLÇÜLERİ(EN X BOY X H)	SIZES	1000 x 3460 x 2500mm	1000 x 3460 x 2500mm
AĞIRLIK	WEIGHT	575 kg.	680 kg.
TİTREŞİM	VIBRATION	1 ad.	1 ad.

Özel Kalibre Seyyar Toz Toplama Sistemleri / Calibrated dust collection system

UNS284-FTK

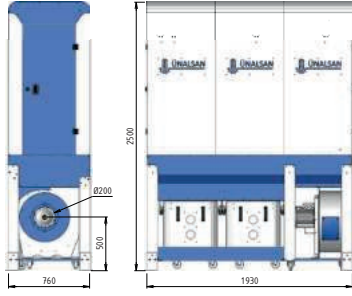

UNS284-GTK

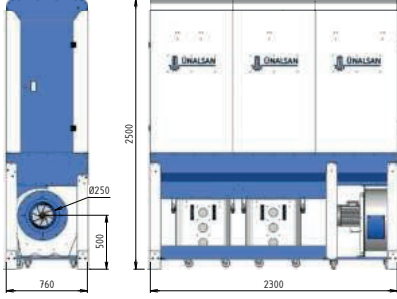

UNS284-HTK

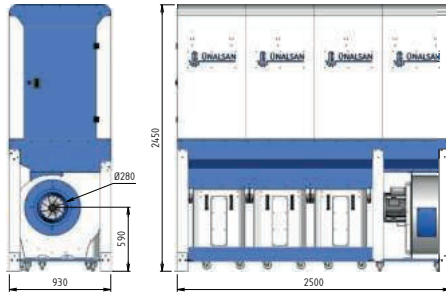

UNS284-KTK

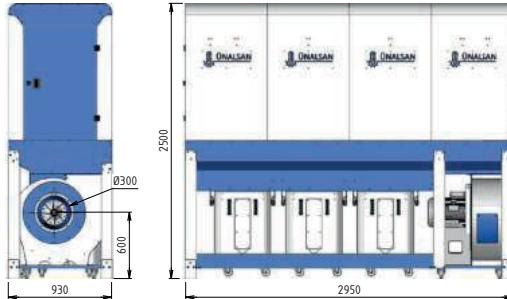

Özel Kalibre Seyyar Toz Toplama Sistemleri / Calibrated Dust Collection System

ÜRÜN KODU	CODE	UNS 284 FTK	UNS 284 GTK	UNS 284 HTK	UNS 284 KTK
KAPASİTE (DEBİ)	CAPACITY	3500 m3/h	4000 m3/h	5000 m3/h	6500 m3/h
MOTOR GÜCÜ MOTOR	POWER	3 kw / 4 hp / 3000 dd	3 kw / 4 hp / 3000 dd	5,5 kw / 7,5 hp / 3000 dd	7,5 kw / 10 hp / 3000 dd
EMİŞ HIZI	VACUUM VELOCITY	28 m/sn	28 m/sn	28 m/sn	32 m/sn
EMİŞ ÇAPI	VACUUM DIAMETER	Ø200 mm	Ø250 mm	Ø280 mm	Ø300 mm
FİLTRE CİNSİ	FILTER TYPE	Antistatik Polyester	Antistatik Polyester	Antistatik Polyester	Antistatik Polyester
FİLTRE GEÇİRGENLİĞİ	DUST HOLDING CAPACITY	2 micron	2 micron	2 micron	2 micron
FİLTRE ÖLÇÜSÜ	FILTER SIZE	Ø160x1300 mm	Ø160x1300 mm	Ø160x1100 mm	Ø160x1100 mm
FİLTRE ADEDİ	FILTER QUANTITY	27 adet	32 adet	47 adet	60 adet
TALAŞ BİRİKTİRME KAPASİTESİ	DUST STORAGE CAPACITY	Metal Kova 2 adet	Metal Kova 2 adet	Metal Kova 3 adet	Metal Kova 3 adet
ELEKTRİK	ELECTRICITY	380 v	380 v	380 v	380 v
ÖLÇÜLERİ	SIZES	760x1930x2515 mm	760x2300x2515 mm	925x2500x2450 mm	925x2950x2480 mm
AĞIRLIK	WEIGHT	320 kg	400 kg	473 kg	560 kg
TİTREŞİM	VIBRATION	1 adet	1 adet	1 adet	1 adet

Jet-Pulse Toz Filtrasyon Sistemleri / Jet Pulse Dust Collectors



Jet-Pulse Toz Filtrasyon Sistemleri / Jet-Pulse Dust Filtration Systems

ÜRÜN KODU	CODE	UNS 2025	UNS 2026	UNS 2027	UNS 2028	UNS 2029	UNS 2030
KAPASİTE	CAPACITY	10.000m3/h	15.000m3/h	20.000m3h	25.000m3/h	30.000m3/h	35.000m3/h
BOŞALTMA SİSTEMİ	UNLOADING SYSTEM	Metal Kova	Metal Kova	Metal Kova	Metal Kova	Metal Kova	Metal Kova
KOVA ÖLÇÜLERİ	METAL BUCKET SIZE	Ø500x500	Ø500x500	Ø950x950	Ø950x950	Ø950x950	Ø950x950
KOVA ADEDİ	METAL BUCKET NUMBER	2 adet	2 adet	3 adet	4 adet	4 adet	4 adet
VALF TİPİ	VALVE TYPE	220V A.C 1"	220V A.C 1"	220V A.C 1"	220V A.C 1"	220V A.C 1"	220V A.C 1"
VALF SAYISI	VALVE QUANTITY	10 adet	12 adet	19 adet	24 adet	24 adet	28 adet
FİLTRE ADEDİ	FILTER QUANTITY	70 adet	120 adet	190 adet	240 adet	240 adet	280 adet

Filtre Teknik Özellikleri / Filter Specifications

ÜRÜN KODU	CODE	UNS 2025	UNS 2026	UNS 2027	UNS 2028	UNS 2029	UNS 2030
BİRİM AĞIRLIĞI	WEIGHT UNIT	525 gr/m2	525 gr/m2	525 gr/m2	525 gr/m2	525 gr/m2	525 gr/m2
MALZEME CİNSİ	TYPE OF MATERIAL	A.Polyester	A.Polyester	A.Polyester	A.Polyester	A.Polyester	A.Polyester
FİLTRE TİPİ	FILTER TYPE	Tel Kafesli	Tel Kafesli	Tel Kafesli	Tel Kafesli	Tel Kafesli	Tel Kafesli
YÜZEY ALANI	SURFACE AREA	89,37m2	180,86m2	287m2	362m2	362m2	423m2
FİLTRE BOYU	FILTER LENGTH	2500mm	3000mm	3000mm	3000mm	3000mm	3000mm
FİLTRE ÇAPI	FILTER DIAMETER	160 mm	160 mm	160 mm	160 mm	160 mm	160 mm
FİLTRE HIZI	FILTER SPEED	1.85m/dak	1.85m/dak	1.85m/dak	1.85m/dak	1.85m/dak	1.85m/dak
HAVA FİLTRE DEBİSİ	AIR FILTER FLOW	2500Nm3/h	2500Nm3/h	2500Nm3/h	2500Nm3/h	2500Nm3/h	2500Nm3/h
HAVA FİLTRE DEBİSİ	AIR FILTER FLOW	2500Nm3/h	2500Nm3/h	2500Nm3/h	2500Nm3/h	2500Nm3/h	2500Nm3/h
ÇALIŞMA BASINCI	OPERATING PRESSURE	250-500 mmh2o	250-500 mmh2o	250-500 mmh2o	250-500 mmh2o	250-500 mmh2o	250-500 mmh2o

Siklonlar / Cyclones

UNS-421

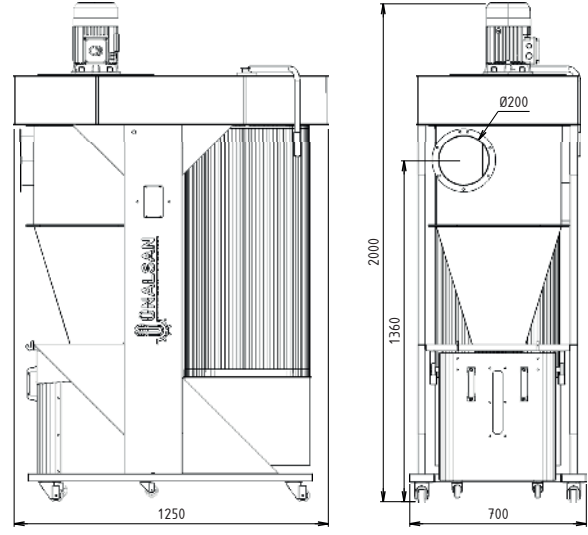

Siklon / Cyclones

ÜRÜN CODE	KAPASİTE CAPACITY	MOTOR GÜCÜ MOTOR POWER	ÇAP Ø DIAMETER	FİLTRE TİPİ FILTER TYPE	TALAŞ BİRİKTİRME DUST STROGE	ELEKTRİK ELECTRICITY	ÖLÇÜLERİ SIZES	AĞIRLIK WEIGHT
Uns 421	3000m ³ /h	2,2 kw 3000d/d	Ø200 2x125	Kartuş	460x500mm h=500mm	380 V	700x1250mm h=2000mm	160 kg

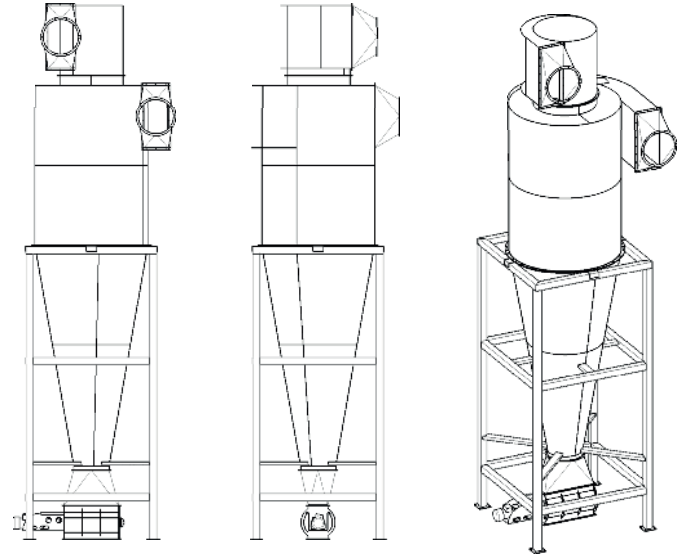

Siklon / Cyclones

KOD / CODE	KAPASİTE / CAPACITY	EN	BOY	YÜKSEKLİK
Uns-412	6.500m ³ /h	1000	1000	3500
Uns-413	10.000m ³ /h	1600	1600	5700
Uns-414	15.000m ³ /h	1600	1600	6300
Uns-415	25.000m ³ /h	2000	2000	7000
Uns-416	35.000m ³ /h	2400	2400	8000

Zımpara Masası / Downdraft Table

UNS-297

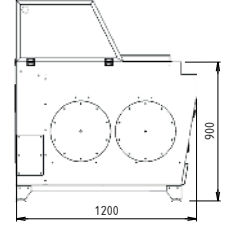
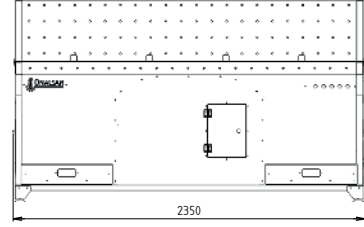

Vakumlu Zımparalama Masası / Downdraft Table

ÜRÜN KODU	CODE	UNS 297-P
KAPASİTE (DEBİ)	CAPACITY	5000 m ³ /h
MOTOR GÜCÜ	MOTOR POWER	5,5 kw 7,5 hp
TOZ EMME HIZI	VACUUM VELOCITY	14 m/s
FİLTRE CİNSİ	FILTER TYPE	Polyester Kartuş Filtre (Donaldson)
FİLTRE GEÇİRGENLİĞİ	DUST HOLDING	1 Micron
FİLTRE ÖLÇÜSÜ	FILTER SIZES	Ø324mm, L:660mm
FİLTRE ADEDİ	FILTER QUANTITY	4 adet
FİLTRE YÜZEY ALANI	FILTER SURFACE AREA	83,2 m ²
VALF	VALVE	4 Adet, 3/4" (Smc-JSXFA)
TALAŞ BİRİKTİRME	DUST STORAGE CAPACITY	Metal Çekmece (2 Ad.)
ELEKTRİK	ELECTRICITY	380v
ÖLÇÜLERİ (EN X BOY X H)	SIZES	1200x2350x900 mm
AĞIRLIK	WEIGHT	435 kg

UNS-294

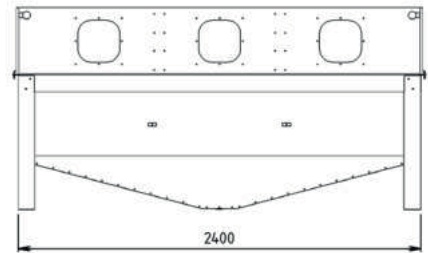
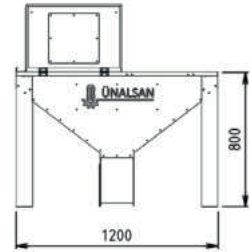

Zımparalama Masası / Downdraft Table

KOD	CODE	UNS 291	UNS292	UNS 293	UNS 294
EN (mm)	WIDTH (mm)	1000 mm	1000 mm	1000 mm	1200 mm
BOY (mm)	LENGTH (mm)	1000 mm	2000 mm	2400 mm	2400 mm
YÜKSEKLİK (mm)	HEIGHT (mm)	835 mm	835 mm	835 mm	835 mm

Spiral Boru Ve Bağlantı Elemanları / Spiral Duct and Fittings



Ø80mm'den Ø600mm'ye kadar spiral boru imalatı yapılmaktadır. Ø125mm'den Ø600mm'ye kadar çatal, dirsek ve redüksiyon imalatı yapılmaktadır.

Uygulamalarımızda, spiral borular kullanılır ve birleştirmeleri flanşlar ile yapılır. Bu sayede borunun iç kısmında pürüzsüz yüzey elde edilir ve pvc gibi uzun lifli parçalarla tıkanmasının önüne geçilir.

Spiral duct is manufactured from Ø80mm to Ø600mm Elbows, laterals and reducers are manufactured from Ø125mm to Ø600mm.

Spiral ducts are used and ducts are connected via flanges in our applications. Thus smooth surface is provided inside the duct and the ducts are prevented by being blocked with long stringed chips such as pvc.

ELLE SÜRGÜLÜ KLAPE HAND SLIDING CLACK

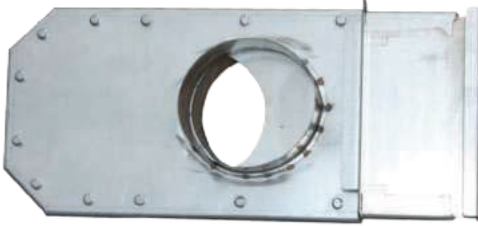

Ø80mm'den Ø600mm'ye kadar sürgülü ve pnömatik klapeler imalatı yapılmaktadır.

Hand sliding and pneumatic sliding clacks are manufactured from Ø80mm to Ø600mm.

PNÖMATİK SÜRGÜLÜ KLAPE PNEUMATIC SLIDING CLACK

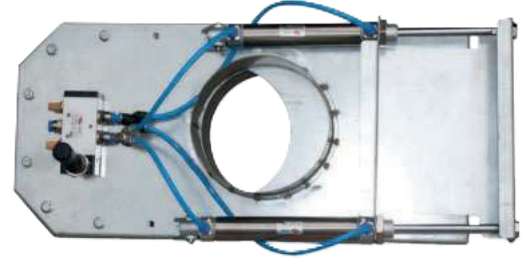

PARÇA TUTUCU PART SEPARATOR

Pvc ve tahta parçası vb. radyal fana gitmesi istenilmeyen taneleri ayıran parçadır. Farklı ölçülerde imalatı yapılmaktadır.

The part separates the pieces such as pvc and wooden parts which are undesired to pass towards the fan. Part separators are manufactured in different sizes.



Tarih / Date:/...../.....

Firma Adı <i>Company Name</i>		Gsm	
Görüşülen Kişi <i>Contact Person</i>		Email	

--



Ünalsan Metal ve Makina San. Tic. A.Ş.

Alaaddinbey Mah. Alaaddinbey Köy Yolu Cad.
Ünalsan Blok No: 18 Nilüfer / BURSA - TÜRKİYE
Tel: +90 224 413 41 40 (pbx) Fax: +90 224 413 03 86
www.unalsan.com info@unalsan.com



web



facebook



instagram



linkedin

